

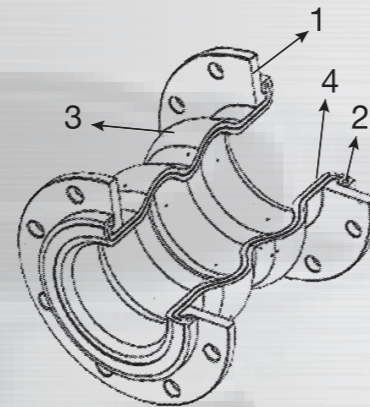

## TWIN-SPHERE CONNECTORS

Model : Series TT



1. Flange
2. Wire
3. Elastomer
4. Reinforcing Fat  
Twin-Sphere

### Material Specification

Item	Part	Material
1	Flanges	SS41 (changeable)
2	Wire	Carbon Steel Wires Strand
3	Elastomer	Special Synthetic Rubber
4	Reinforcing Fabric	Synthetic Fiber

### Operating Conditions

Size I.D.	1" ~ 12" 25mm ~ 300mm		14" ~ 24" 350mm ~ 600mm	
	PSIG	kPa	PSIG	kPa
<b>Working Pressure</b>	228	1,569	114	785
<b>Burst Pressure</b>	854	5,884	342	2,353
<b>Vacuum Rating</b>	650mm/Hg			
<b>Temperature</b>	~20°C ~ 100°C / -4F° ~ 212°F			

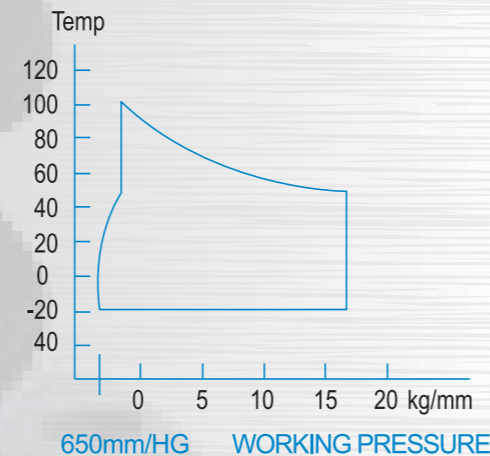

### With Control Rods

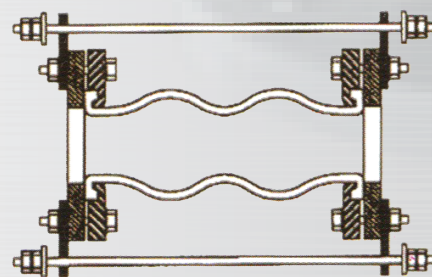

Installed with control rods to prevent internal pressure and motion by over limit usage and vacuum for dropping. Control rods and Reinforcing Ring unit must be installed when pressure (test surge, Operating, starting a pump, etc.) exceeds the rating below :

### References

1. Elastomer Materials - Neoprene, Butyl, Nitrile, EPDM, Hypalon, SBR, Natural rubber for your specifications.
2. Flange drilling - JIS, DIN, ANSI, BS and other standard drilling for your specifications.
3. Applicable fluids - water, warm water, seawater, weak acids, alkalis, etc.
4. 1 PSIG = 14.25kg/cm<sup>2</sup>

### Allowable Movements

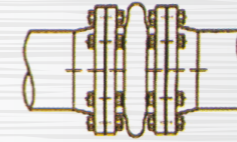

Axial Compression

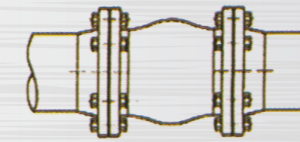

Axial Extension

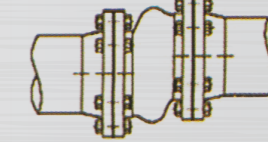

Lateral Movement

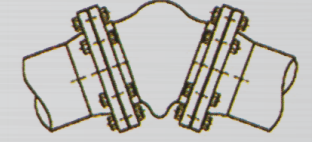

Angular Deflection

Item No.	Size I.D.	F ø	L	Compression	Extension	Lateral	Angular
TT-101H	1-1/2 inch ( 40mm )	68mm	175mm	50mm	30	45mm	35°
TT-102	2 inch ( 50 mm )	86mm	175mm	50mm	30	45mm	35°
TT-102H	2-1/2 inch ( 65 mm )	105mm	175mm	50mm	30	45mm	35°
TT-103	3 inch ( 80 mm )	115mm	175mm	50mm	30	45mm	35°
TT-104	4 inch ( 100 mm )	150mm	225mm	50mm	35	40mm	35°
TT-105	5 inch ( 125 mm )	179mm	225mm	50mm	35	40mm	35°
TT-106	6 inch ( 150 mm )	210mm	225mm	50mm	35	40mm	35°
TT-108	8 inch ( 200 mm )	260mm	325mm	60mm	35	35mm	30°
TT-110	10 inch ( 250 mm )	320mm	325mm	60mm	35	35mm	30°
TT-112	12 inch ( 300 mm )	367mm	325mm	60mm	35	35mm	30°
TT-114	14 inch ( 350 mm )	408mm	350mm	50mm	40	30mm	20°
TT-116	16 inch ( 400 mm )	472mm	350mm	50mm	40	30mm	20°
TT-118	18 inch ( 450 mm )	522mm	350mm	50mm	40	30mm	20°
TT-120	20 inch ( 500 mm )	570mm	350mm	50mm	40	30mm	20°
TT-124	24 inch ( 600mm )	570mm	350mm	50mm	40	30mm	20°

Size I.D.	1½" ~ 4" 40mm ~ 100mm	5" ~ 10" 125mm ~ 250mm	12" ~ 14" 300mm ~ 350mm	16" ~ 24" 400mm ~ 600mm
<b>PSIG</b>	150	135	90	45
<b>kPa</b>	1,035	931	621	310